



Technical Specifications *

Accuracy:	< 2% of FS range under constant conditions
Analysis:	0-100 ppm, 0-25% FS ranges
Application:	Oxygen analysis in inert, hydrocarbon, helium, hydrogen, mixed and acid (CO ₂) gas streams
Approvals:	None; certified components designed to meet explosion proof standards
Area Classification:	Class 1, Division 1, Groups C, D hazardous areas
Alarms:	None
Calibration:	Max interval—3 months. Use certified span gas with O ₂ content (balance N ₂) approximating 80% of full scale for fast 20-30 minute recovery to online use. Alternatively, air calibrate with clean source of compressed or ambient (20.9% O ₂) air on 0-25% range and allow 60 minutes on zero gas to recover to 10 ppm. For optimum accuracy, calibrate one range higher than the range of interest.
Compensation:	Temperature
Connections:	1/8" compression tube fittings
Controls:	Integral 4-20mA zero and span pots, and range selector
Display:	LCD 3-1/2 digits; resolution .1 ppm
Enclosures:	Aluminum ex-proof NEMA 4X wall mt. 12x8x10"; 15 lbs
Flow Sensitivity:	Not flow sensitive; recommended flow rate 1-2 SCFH
Linearity:	> .995 over all ranges
Pressure:	Inlet - regulate to 5-30 psig; vent - atmospheric
Power:	18-24 VDC 2 Wire Loop
Recovery Time:	60 seconds in air to < 10 ppm in < 2 hours on N ₂ purge
Response Time:	90% of final FS reading in 15 seconds
Sample System:	None; optional H ₂ S sample system(s) for natural gas extraction, transmission and processing
Sensitivity:	< 0.5% of FS range
Sensor Model:	XLT-12-100-M with > 0.5% CO ₂ present GPR-12-100-M sensor for non-CO ₂ gas streams
Sensor Life:	24 months in < 1000 PPM O ₂ at 25°C and 1 atm
Signal Output:	4-20mA non-isolated
Temp. Range:	5° to 45°C (GPR sensor); -10° to 45°C (XLT sensor);
Warranty:	12 months analyzer; 12 months sensor
Wetted Parts:	Stainless steel

Complies with recognized explosion proof standards for Hazardous Areas



GPR-15 XP Explosion Proof PPM Oxygen Transmitter

Full Featured O₂ Transmitter with Advanced Galvanic Sensor Technology

Certified components designed to meet Class I, Division 1, Groups C, D

18-24 VDC 2 Wire Loop Power Sensitivity 0.5% Full Scale

2 Ranges Standard

Flame Arrestors

SS Wetted Parts

4-20mA Signal Output

Optional Equipment

Sample conditioning accessories - contact factory

* Subject to change without notice

ISO 9001:2008 Certified
INTERTEK Certificate No. 485



Advanced Instruments Inc.

GPR-15 XP
ppm O₂ Transmitter

Owner's Manual

Advanced Instruments Inc.

Table of Contents

<i>Introduction</i>	1
<i>Quality Control Certification</i>	2
Includes Modifications to Standard Analyzer (if any)	
<i>General Safety</i>	3
<i>Features</i>	4
<i>Operation</i>	5
5-1 Principle of Operation 5-2 Pressure and Flow 5-3 Installation 5-4 Calibration	
<i>Maintenance</i>	6
<i>Spare Parts</i>	7
<i>Troubleshooting</i>	8
Symptom - Possible Cause - Recommended Action	
<i>Specifications</i>	9
Specification of Standard Analyzer Outline Diagram Flow Diagram Interconnection Diagram	
<i>Warranty</i>	10
What is covered, What we will do Limitations How to obtain warranty service What is not covered	
<i>Material Safety Data Sheets</i>	

Advanced Instruments Inc.

1 Introduction

Congratulations on Your Purchase

Your new oxygen analyzer is a precision piece of equipment designed to give you years of use in variety of industrial oxygen applications.

This analyzer is designed to measure the oxygen concentration in inert gases, gaseous hydrocarbons, hydrogen, a variety of gas mixtures and acid gases with 0-100% CO₂ (requires the XLT series sensor) present.

In order to derive maximum performance from your new oxygen analyzer, please read and follow the guidelines provided in this Owner's Manual.

The serial number of this analyzer may be found on the inside the analyzer. You should note the serial number in the space provided and retains this Owner's Manual as a permanent record of your purchase, for future reference and for warranty considerations.

Serial Number: _____

Every effort has been made to select the most reliable state of the art materials and components designed for superior performance and minimal cost of ownership. This analyzer was tested thoroughly by the manufacturer for best performance. However, modern electronic devices do require service from time to time. The warranty included herein plus a staff of trained professional technicians to quickly service your analyzer is your assurance that we stand behind every analyzer sold.

Advanced Instruments Inc. appreciates your business and pledge to make effort to maintain the highest possible quality standards with respect to product design, manufacturing and service.

Advanced Instruments Inc.

2 Quality Control Certification

		<u>Pass</u>
Date		
Customer		Order No.: _____
Model	GPR-15 XP ppm O2 Transmitter	Serial No.: _____
Sensor	() GPR-12-100-M ppm Oxygen Sensor (0-100 ppm, 0°C)	Serial No.: _____
	() XLT-12-100-M ppm Oxygen Sensor (0-100 ppm, 0°C)	_____
Accessories	Owner's Manual	_____
Configuration	A-1139-M PCB Assembly	_____
	Range: 0-25% CAL (range 1), 0-100 ppm (range 2)	_____
	Power: 13-36V DC two wire loop power	_____
	Wetted parts: Stainless steel, delrin sensor	_____
	Viewing window in cover	_____
	Explosion proof wall mount enclosure with flame arrestors	_____
Test - Electronics	Electronic offset	_____
	4-20mA offset	_____
	Analog signal output 4-20mA	_____
Test - Gas Phase	Baseline drift on zero gas $< \pm 2\%$ FS over 24 hour period	_____
	Noise level $< \pm 1.0\%$ FS	_____
	Span adjustment within 10-50% FS	_____
Final	Overall inspection for physical defects	_____
Options	Sub-freezing temperature range requires sensor, LCD change.	
	() GPR-12-100-ML ppm Oxygen Sensor (0-100 ppm, -30°C)	_____
	() XLT-12-100-ML ppm Oxygen Sensor (0-100 ppm, -20°C)	_____
	MTR-1007 Meter LCD digital display rated for -30°C	_____
Notes		_____

3 Caution

General

This section summarizes the essential generic precautions applicable to all transmitters. Additional precautions specific to individual transmitters are contained in the following sections of this manual. To operate the transmitter safely and obtain maximum performance follow the basic guidelines outlined in this Owner's Manual.

Caution: This symbol is used throughout the Owner's Manual to CAUTION and alert the user to recommended safety and/or operating guidelines.

Danger: This symbol is used throughout the Owner's Manual to identify sources of immediate DANGER such as the presence of hazardous voltages.

Read Instructions: Before operating the transmitter read the instructions.

Retain Instructions: The safety precautions and operating instructions found in the Owner's Manual should be retained for future reference.

Heed Warnings: Follow all warnings on the transmitter, accessories (if any) and in this Owner's Manual.

Follow Instructions: Observe all precautions and operating instructions. Failure to do so may result in personal injury or damage to the transmitter.

Pressure and Flow ***Ref: Section 5 Operation***

Inlet Pressure: The maximum sample gas inlet pressure is 50 psig.

Outlet Pressure: The sample gas vent pressure should be atmospheric.

Installation ***Ref: Section 5 Operation***

Oxygen Sensor: DO NOT open the sensor. The sensor contains a corrosive liquid electrolyte that could be harmful if touched or ingested, refer to the Material Safety Data Sheet contained in the Owner's Manual appendix. Avoid contact with any liquid or crystal type powder in or around the sensor or sensor housing, as either could be a form of electrolyte. Leaking sensors should be disposed of in accordance with local regulations.

Mounting: The transmitter control unit is approved for indoor use only and should be mounted only as recommended by the manufacturer.

Power: Supply power to the transmitter only as rated by the specification in Section 9 and/or markings on the transmitter enclosure. The wiring/cords that connect the transmitter to the power source should be installed in accordance with recognized electrical standards and so they are not pinched particularly near the power source and the point where they attach to the transmitter. Never yank a power cord to remove it from an outlet or from the transmitter.

Operating Temperature: The maximum operating temperature is 45° C.

Heat: Situate and store the transmitter away from sources of heat.

3 Caution

Liquid and Object Entry: The transmitter should not be immersed in any liquid. Care should be taken so that liquids are not spilled into and objects do not fall into the inside of the transmitter.

Handling: Do not use force when using the switches and knobs. Before moving your transmitter be sure to disconnect the wiring/power cord and any cables connected to the output terminals located on the transmitter.

Maintenance
Ref: Section 6

Serviceability: Except for replacing the oxygen sensor, there are no parts inside the transmitter for the operator to service.

Only trained personnel with the authorization of their supervisor should conduct maintenance.

Oxygen Sensor: DO NOT open the sensor. The sensor contains a corrosive liquid electrolyte that could be harmful if touched or ingested, refer to the Material Safety Data Sheet contained in the Owner's Manual appendix. Avoid contact with any liquid or crystal type powder in or around the sensor or sensor housing, as either could be a form of electrolyte. Leaking sensors should be disposed of in accordance with local regulations.

Troubleshooting: Consult the guidelines in Section 8 for advice on the common operating errors before concluding that your transmitter is faulty.

Do not attempt to service the transmitter beyond those means described in this Owner's Manual. Do not attempt to make repairs by yourself as this will void the warranty as per Section 10 and may result in electrical shock, injury or damage. All other servicing should be referred to qualified service personnel.

Cleaning: The transmitter should be cleaned only as recommended by the manufacturer. Wipe off dust and dirt from the outside of the unit with a soft damp cloth then dry immediately. Do not use solvents or chemicals.

Nonuse Periods: If the transmitter is equipped with a range switch advance the switch to the OFF position and disconnect the power when the transmitter is left unused for a long period of time.

Advanced Instruments Inc.

4 Features

Accurate stable ppm O₂ analysis

The Advanced Instruments Inc. GPR-15 XP and GPR-15A XP ppm O₂ Transmitters signal a new level of precision in oxygen measurements. Innovatively designed sensor housing, modular state of the art electronics and an advanced galvanic fuel cell technology deliver maximum performance with the lowest cost of ownership available.

Explosion proof configuration Integral flame arrestors

The wall mount explosion proof enclosure and integral flame arrestors make the GPR-15 XP and GPR-15A XP suitable for use in Class 1, Division 1, Group B, C, D classified areas.

Two wire loop power 4-20mA output

GPR-15 XP provides a 4-20mA signal output from the two-wire loop of a 9-36V DC power source and is represented on full scale oxygen readings to an external device.

4-20mA output plus 2 alarm contacts

GPR-15A XP provides a 4-20mA signal output and two adjustable alarms with relay contacts from a 9-36V DC power source. The 4-20mA output is also represented on full scale oxygen readings to an external device.

Cost effective 0-100 ppm low range

These transmitters can be configured for any full scale measuring range between 100 ppm and 1% oxygen and provide the most cost effective ppm oxygen measurements.

Dual ranges

A second 0-25% range is provided for air calibration.

Sensitivity

The GPR-15 XP and GPR-15A XP respond to industry's growing demand for cost effective ppm oxygen measurements in hazardous areas with sensitivity of 500 ppb or .5 ppm on the 0-100 ppm range.

Versatile long life sensor

Linear over all ranges

Air or span gas calibration

At the heart of the analyzer is an advanced range of galvanic fuel cell type electrochemical sensors with proven linearity and specific for oxygen. Engineered for superior performance and quality, expected life is 18-24 months in inert gases, H₂, He, gaseous hydrocarbons and acid (CO₂) gases.

LCD local display

To facilitate calibration and local spot checking of oxygen readings, the oxygen concentration of the sample is read from a 3-1/2 digit LCD display.

Electronic zero

To maximize accuracy an electronic zero offsets minor electronic variations in the 4-20mA integrated circuit.

Span adjustment

The oxygen reading is adjusted during calibration via a potentiometer.

Sub-freezing operating ranges

Optional advanced sensors and low temperature LCD enable these transmitters to operate at -30°C and -20°C.

5 Operation

Principle of Operation

The GPR-15 ppm and GPR-25 % Series of oxygen transmitters incorporate a variety of advanced galvanic fuel cell type sensors. The sensors function on the same principle and are specific for oxygen. They measure the partial pressure of oxygen from low ppm to 100% levels in inert gases, gaseous hydrocarbons, helium, hydrogen, mixed gases, acid gas streams and ambient air.

Oxygen, the fuel for this electrochemical transducer, diffusing into the sensor reacts chemically at the sensing electrode to produce an electrical current output proportional to the oxygen concentration in the gas phase. The sensor's signal output is linear over all ranges and remains virtually constant over its useful life. The sensor requires no maintenance and is easily and safely replaced at the end of its useful life.

Proprietary advancements in design and chemistry add significant advantages to an extremely versatile oxygen sensing technology. Sensors for low ppm analysis recover from air to ppm levels in minutes, exhibit longer life and reliable quality.

The expected life of our new generation of percentage range sensors now range to five and ten years with faster response times and greater stability.

Another significant development involves expanding the operating temperature range for both ppm and percentage range sensors from -30°C to 50°C.

The signal generated by the sensor is amplified by state of the art low power analog circuitry. The second stage eliminates the low frequency noise. The third stage employs a high frequency filter and compensates for signal output variations caused by ambient temperature changes. The result is a very stable signal.

Sample oxygen is analyzed very accurately with excellent stability. Response time is 90% of full scale in less than 10 seconds on all ranges. Sensitivity is typically 0.5% of full scale low range.

In addition to the aforementioned ppm and % model range distinction, these transmitters offer two basic electronic configurations.

The GPR-15, 15D, 15XP, 25, 25MO, 25S, 25XP model designation denotes a 4-20mA signal output provided on the two-wire loop of a 13-36V DC power source and is represented on full scale oxygen readings to an external device.

Models with the XP suffix are explosion proof and with the required conduit for the electrical wiring connections are suitable for use in Class 1, Division 1, Groups A-D hazardous areas. The remaining model numbers, when used in conjunction with optional intrinsic safety barriers (requiring a minimum of 24V DC) meet recognized standards for intrinsic safety and are suitable for use in Class 1, Division 1, Groups A-D hazardous areas.

The GPR-15A, 15AD, 15AXP, 25A, 25AXP model designation denotes a 4-20mA signal output and two adjustable alarms with relay contacts from a 9-36V DC power source. The 4-20mA output is also represented on full scale oxygen readings to an external device.

Models with the XP suffix are explosion proof and with the required conduit for the electrical wiring connections are suitable for use in Class 1, Division 1, Groups A-D hazardous areas.

5 Operation

Pressure and Flow

All electrochemical oxygen sensors respond to partial pressure changes in oxygen. Flowrates of 1-5 SCFH cause no appreciable change in the oxygen reading provided no significant backpressure is produced. Although sample flow control is not critical, an integral metering valve is provided/recommended as a means of controlling the flowrate of the sample gas. A flowrate of 2 SCFH or 1 liter per minute is recommended for optimum performance.

To avoid erroneous oxygen readings and damaging the sensor:

1. Assure the SHUT OFF valve is completely open, if one is installed.
2. Assure there are no restrictions in the inlet sample line could create and draw a vacuum on the sensor.
3. Avoid excessive flow rates. Above 5 SCFH backpressure is generated, particularly if the sample gas is not properly vented.
4. Avoid sudden releases of backpressure that can severely damage the sensor.
5. Assure no particulates, liquids or condensation collect on the sensor that could block the diffusion of oxygen into the sensor.

Sampling General Procedure:

1. Assure the SHUT OFF valve is completely open, if one is installed.
2. Set the sample gas pressure between 5 and 30 psig (100 psig maximum to retain the precision from the flow control valve).
3. Connect the sample gas line to the sample inlet.
4. Set the sample gas flow rate to 2 SCFH (backpressure results above 5 SCFH)
5. Allow the oxygen reading to stabilize and advance the range switch accordingly to obtain maximum resolution.

Positive Pressure Applications:

A metering valve is recommended for controlling the sample flowrate between 1-5 SCFH. If necessary, a pressure regulator (with a metallic diaphragm is recommended to prevent high oxygen readings resulting from the use of diaphragms of more permeable materials) upstream of the flow control valve should be used to regulate the pressure.

Atmospheric or Slightly Negative Pressure Applications:

For accurate ppb, ppm and low percentage range measurements, a sample pump is required downstream of the unit's sample outlet to draw the sample by the sensor. Vacuum should not exceed 14" of water. A metering valve is necessary to obtain the recommended flow rate. Placement and leakage rate of the pump is not normally a consideration for higher percentage measurements.

If pump loading is a consideration, a second throttle valve on the pump's inlet side may be necessary to provide a bypass path so the sample flowrate is within the above parameters.

5 Operation

Installation

Percent Transmitters

The percent versions, GPR-25, 25A, 25 XP, 25A XP O₂ Transmitters are fully operational from the shipping container with the oxygen sensor installed and calibrated by the manufacturer prior to shipment. If equipped with the optional metal sensor housing, the sensor may be shipped separately as described below.

ppm Transmitters

The ppm versions, GPR-15, GPR-15A, GPR-15D, GPR-15AD, GPR-15 XP, GPR-15A XP, have been fully tested and calibrated using the accompanying oxygen sensor by the manufacturer prior to shipment. The ppm sensor is shipped separately in a nitrogen filled barrier bag to maintain its expected useful life and low end sensitivity. The ppm sensor requires installation and should be calibrated in air at that time. Once in service, calibrating the ppm transmitter with a certified span gas is recommended except in emergency situations where air may be used for calibration.

The sensor is packaged for shipment in a plastic container to protect the barrier bag containing the oxygen sensor. Do not open, particularly in the case of a ppm sensor, or puncture the barrier bag containing the oxygen sensor until such time as the sensor is to be actually installed.

A ppm sensor exposed to air will require a longer period of time to reach zero after installation. The low end sensitivity may be adversely impacted depending on the time the sensor is exposed to air.

Mounting the Enclosure

1. Remove the front cover of the transmitter by removing the four (4) screws securing the general purpose models or set screw retaining the screw off cover the explosion models. Set them aside for reinstallation.
2. General purpose models, remove the front cover of the junction box located on left side of the transmitter and the four (4) screws securing it and set them aside for reinstallation.

 **Caution:** Do not remove or discard the gaskets from either the enclosure or junction box. Failure to reinstall either gasket will void the NEMA rating.

 **Caution:** The transmitter design provides for RFI protection that is maintained by leaving specific mating areas of the enclosure unpainted to maintain conductivity. These unpainted areas are protected by gaskets and do not impact the NEMA rating.

3. Do not paint these areas. Painting will negate the RFI protection.

5 Operation

Installation

4. General purpose models - Locate the mounting holes cast into the bottom section of the enclosure and either the black delrin sensor and flow housing or the metal sensor housing. Orient the enclosure by locating the PCB at the top.
5. Explosion proof models - The mounting feet are located on the outside of the enclosure. Orient the enclosure using the silkscreen of the front panel.
6. Secure with appropriate screws or bolts.
7. Mount the base section to the enclosure to a vertical surface at a level accessible to service personnel. This requires the use to supply four (4) additional proper size screws and anchors.

Establishing Power to the Transmitter:

1. Power requirements consist of a two wire 9-36V DC with negative ground power supply.
2. Review the interconnection diagram in Section 9 - Specifications.
3. General purpose models - Connect a two wire shielded cable to the two (2) screw type terminals of the barrier strip inside the junction box. Ensure the positive and negative terminals of the power supply are connected to the terminals of the barrier strip as marked.
4. Connect the shielding of the cable to the copper ground screw inside the junction box.
5. Replace the front cover of the junction box and the four (4) screws.
6. Explosion proof models - Connect a two wire shielded cable to the designated terminals shown by the interconnection wiring diagram in Section 9.

Caution: Hazardous Area Installation

If the transmitter is to be installed in a hazardous area it must be interconnected with suitable intrinsic safety barriers and a barrier enclosure approved for use with the safety barrier selected.

MTL 702 type barriers and a 24VDC power supply with two (2) wire shielded cable are recommended. Requirements include a 4-20mADC two (2) wire signal and a power requirement of 20mADC per channel at 24VDC minimum.

The following chart identifies the required wire based on the distance from the safety barriers to the two wire transmitter.

4,500 ft. - 22 AWG
7,200 ft. - 20 AWG
11,500 ft. - 18 AWG
18,500 ft. - 16 AWG
29,500 ft. - 14 AWG

5 Operation

Installation

Output – Two Wire Loop Powered Transmitters

The 4-20mA current output is obtained by connecting the current measuring device between the negative terminal of power source and the negative terminal, marked (-), located in the junction box of the transmitter. Refer to the appropriate diagram in Section 9. The positive current flow is from pin 1 to pin 2 and from pin 2 to ground through the external load.

Output – Non-loop Powered Transmitters

The 4-20mA current output is obtained by connecting the current measuring device to the output terminal shown by the interconnection wiring diagram.

 **Caution:** To assure proper grounding, connect the 4-20mA signal output to the external device (PLC, DCS, etc.) before attempting any zero or span adjustments.

Connecting the Sample Lines:

Connect the sample gas line and the vent line to the compression tube connections provided.

Follow the guidelines under Pressure and Flow section to set the proper pressure and flow rates.

Sensor (if required)

The standard percent, GPR-25 Series O₂ Transmitters are fully operational from the shipping container with the oxygen sensor installed and calibrated by the manufacturer prior to shipment. Calibrate if desired as described in the Calibration Section once power has been established to the transmitter. If equipped with the optional metal sensor housing follow the procedure described under the ppm transmitter below.

The ppm, GPR-15 Series O₂ Transmitters require the sensor to be installed (ppm sensors are shipped separately in nitrogen purged barrier bag for maximum life) and calibrated using the procedure described in the Calibration Section once power has been established to the transmitter.

5 Operation

Calibration

Percent transmitters equipped in standard form with the delrin sensor and flow housing are fully operational from the shipping container with the oxygen sensor installed and calibrated by the manufacturer prior to shipment.

ppm transmitters are shipped with the oxygen sensor packaged separately (in nitrogen purged barrier bags to optimize operating life) and should be calibrated in air at installation.

Maximum drift from calibration temperature is approximately 0.11% of reading per °C. Calibration is recommended every 3-4 months, or as determined by the user's application, using air on the CAL range or certified span gas approximately 80% of full scale on range of interest. For ranges below 0-100 ppm, air calibration is recommended when installing a new sensor or as an emergency backup.

 **Caution:** To assure proper grounding, connect the 4-20mA signal output to the external device (PLC, DCS, etc.) before attempting any zero or span adjustments.

Calibrating the transmitter requires setting:

1. The fine adjustment zero potentiometer of the 4-20mA integrated circuit.
2. The span potentiometer.

However, the procedures vary depending on the configuration (sensor and display) of the transmitter and the type of calibration (zero or span). Therefore it will be necessary to describe several procedures based on their frequency and commonality.

Refer to section 9 Specifications and the appropriate PCB schematic to identify and locate the various controls of your specific model.

5 Operation

Calibration

Procedure #1 Span Gas Calibration – Transmitters equipped with LCD display and sensor installed for shipment or in-service:

Applies to:

- Installed GPR-25 standard configuration – LCD and delrin sensor/flow housing
- In-service GPR-15 standard configuration – LCD and sensor with metal housing
- In-service GPR-25 optional configuration – LCD and sensor with metal housing

Notes:

 Span Gas - should have a value of oxygen concentration in N₂ or Ar of 80-100% of full scale; example, for a 0-1% range, the span gas should be a certified grade between 0.8% and 0.9%.

 Accuracy – due to manufacturer tolerances there may be a slight difference between the LCD display and the analog output of the 4-20mA integrated circuit. However, the difference is less than 0.25% of range and falls well below the specified accuracy of the transmitter.

1. Remove the front cover of the transmitter and the screw(s) securing it.

 **Caution:** Do not remove or discard the gasket from the enclosure. Failure to reinstall the gasket will void the NEMA rating.

2. Advance the range switch to the appropriate range.
3. Disconnect the sample gas line.
4. Assure there are no restrictions in the span gas line to be connected.
5. Set the span gas pressure between 5 and 30 psig; refer to the Pressure and Flow guidelines presented on page 2 of this Section 5 Operation.
6. Connect the span gas line and tighten the compression tube fitting.
7. Set the flow of the span gas to 2 SCFH.
8. Allow the sensor and corresponding reading displayed by the LCD to stabilize for at least 15 minutes.
9. Adjust the span potentiometer with a small screwdriver until the oxygen reading reaches the proper span setting. In the case of the example used above, adjust the span pot to 90% of the full scale output or 0.90% oxygen.
10. Reverse steps 1 through 6 above and set the flow to 2 SCFH.

5 Operation

Calibration

Procedure #2 Instrument Air Calibration – Transmitters equipped with LCD display and sensor installed for shipment or in-service:

Except for step 9 and ignoring the Notes: Span Gas section, repeat Procedure #1 ensuring the range switch is set properly to the 0-25% CAL range.

The known concentration of air (20.9%) may be used as the standard for the 0-25% range.

With respect to step 9; adjust the span potentiometer until the oxygen reading displayed by the LCD reaches 20.9%.

Procedure #3 Ambient Air Calibration – Transmitters equipped with LCD display and sensor installed for shipment or in-service:

Except for step 9, ignoring the Notes: Span Gas section and omitting steps 4 through 7, expose the sensor to ambient air and repeat Procedure #1 ensuring the range switch is set properly to the 0-25% CAL range.

The known concentration of air (20.9%) may be used as the standard for the 0-25% range.

With respect to step 9; adjust the span potentiometer until the oxygen reading displayed by the LCD reaches 20.9%.

5 Operation

Calibration

Procedure #4 Ambient Air Calibration -- Transmitters equipped with LCD display and sensor not installed for shipment or being replaced:

Applies to:

- GPR-15 std. configuration – LCD and sensor with metal housing
- GPR-25 opt'l configuration – LCD and sensor with metal housing

Notes:

 Accuracy – due to manufacturer tolerances there may be a slight difference between the LCD display and the analog output of the 4-20mA integrated circuit. However, the difference is less than 0.25% of range and falls well below the specified accuracy of the transmitter.

1. Remove the front cover of the transmitter and the screw(s) securing it.

 **Caution:** Do not remove or discard the gasket from the enclosure. Failure to reinstall the gasket will void the NEMA rating.

2. Advance the range switch to the 0-25% CAL range.
3. Remove the top of the sensor housing by using the 5/16 wrench provided to loosen the clamp bolt, turning the top section of the sensor housing 90° and disengaging the clamp. Refer to drawing A-1003 (brass) or A-1004 (S/S) in Section 9 - Specifications.
4. Place the top section of the sensor housing on a smooth surface.
5. If installing a sensor for the first time go to step 9. If installing a replacement sensor, remove the old sensor from the sensor housing.
6. Once all preparations are complete, remove the new oxygen sensor from the barrier bag.
7. Remove the shorting device and gold ribbon from the PCB located at the rear of the sensor.

 **Caution:** Minimize the exposure to air. Do not remove the shorting device and let the sensor sit in air. In an unshorted condition, the sensor becomes saturated with unreacted oxygen resulting in longer clean up or recovery time and an inaccurate initial air calibration if the span adjustment is made before the sensor stabilizes.

8. Place the sensor on a flat surface with the PCB facing up.
9. Place the top of the sensor housing over the sensor's PCB and push the housing down onto the sensor. Ensure the PCB makes contact with the spring loaded contact pins inside the housing.
10. Allow the sensor and corresponding reading displayed by the LCD to stabilize for 10-15 minutes.

5 Operation

Calibration

11. Adjust the span control until the display reads 20.9% oxygen.
12. Remove the top of the sensor housing and place the oxygen sensor in the bottom section of the sensor housing with the gold screen facing down towards the inside of the housing and the floor.
13. Place the top section of the sensor housing over the PCB and push the top section of the housing down onto the sensor located inside the bottom section of the housing.
14. Ensure the top and bottom section seat together.
15. Turn the top section of the sensor housing 90° and engage the clamp.
16. Using the 5/16 wrench provided tighten bolt and clamp the top and bottom sections of the sensor housing together.
17. Set the sample flow to 2 SCFH and begin sampling.

5 Operation

Calibration

Procedure #5 Zeroing the 4-20mA Integrated Circuit – Transmitters equipped with LCD display and sensor installed for shipment or in-service:

Applies to:

GPR-25 standard configuration – LCD and delrin sensor/flow housing

Notes:

 The zero offset of the 4-20mA integrated circuit (not to be confused with the sensor/sample system offset) has been set at the factory using an oxygen free zero gas that generates a 4.00mA output. The zero doesn't normally require adjustment. However, if it is desired to verify the setting of the electronic zero, follow the procedure as described below.

 **Caution:** Do not attempt to adjust the electronic zero by disconnecting the sensor from the sensor cable or the cable from its PCB connection. The thermistor used for compensating the sensor output for variations in temperature is embedded in the sensor. If the sensor is not connected to the PCB, the output will not equal 4.00mA due to the absence of the thermistor from the circuit.

1. Remove the front cover(s) of the transmitter the screw(s) securing each.

 **Caution:** Do not remove or discard the gaskets from the enclosure or junction box. Failure to reinstall the gasket will void the NEMA rating.

2. Remove the wire inside the junction box connected to the terminal marked "negative".
3. Connect a milliammeter in series between this wire and the terminal marked "negative".
4. Advance the range switch to the least sensitive range, generally 0-25%.
5. Disconnect the sample gas line.
6. Assure there are no restrictions in the zero gas line to be connected.
7. Set the zero gas pressure between 5 and 30 psig; refer to the Pressure and Flow guidelines presented previously.
8. Connect the zero gas line and tighten the compression tube fitting.
9. Set the flow of the zero gas to 2 SCFH.
10. Allow the sensor and corresponding reading displayed by the LCD to stabilize for 30 minutes.

Advanced Instruments Inc.

5 Operation

Calibration

11. If for any reason the output is not 4.00mA, it may be adjusted to 4.00mA by using the zero potentiometer and a small screwdriver.

 Note: Only a very fine adjustment should be required of zero potentiometer to adjust the 4-20mA integrated circuit. If a substantial adjustment is required, other problems probably exist and the factory should be consulted immediately.

5 Operation

Calibration

Procedure #6 Zeroing the 4-20mA Integrated Circuit – Transmitters equipped with LCD display and sensor not installed prior to shipment or in-service:

Applies to:

- GPR-15 standard configuration – LCD and sensor with metal housing
- GPR-25 optional configuration – LCD and sensor with metal housing

Notes:

 The zero offset of the 4-20mA integrated circuit (not to be confused with the sensor/sample system offset) has been set at the factory using an oxygen free zero gas that generates a 4.00mA output. The zero doesn't normally require adjustment. However, if it is desired to verify the setting of the electronic zero, follow the procedure as described below.

1. Remove the front cover(s) of the transmitter and the screw(s) securing each.

 **Caution:** Do not remove or discard the gaskets from the enclosure or junction box. Failure to reinstall the gasket will void the NEMA rating.

2. Remove the wire inside the junction box connected to the terminal marked "negative".
3. Connect a milliampmeter in series between this wire and the terminal marked "negative".
4. Remove the top of the sensor housing by using the 5/16 wrench provided to loosen the clamp bolt, turning the top section of the sensor housing 90° and disengaging the clamp. Refer to drawing A-1003 or A-1004 (S/S) in Section 9 - Specifications.
5. Disconnect the sensor from the top section of the sensor housing.

 **Caution:** Do not disconnect the sensor housing cable from its PCB connection. The thermistor used for compensating the sensor output for variations in temperature is embedded in the top section of the sensor housing. If the top section of the sensor housing is not connected to the PCB, the output will not equal 4.00mA due to the absence of the thermistor from the circuit.

 **Caution:** To the extent possible minimize the time the sensor, particularly the ppm sensor, is exposed to air. Do not let the sensor sit in air any longer than necessary. In an unshorted condition, the sensor becomes saturated with unrecalled oxygen resulting in longer clean up or recovery time and an inaccurate initial air calibration if the span adjustment is made before the sensor stabilizes. The time required for the sensor to stabilize is exponentially related to the time the sensor is exposed to air in an unshorted condition.

5 Operation

Calibration

6. If for any reason the output is not 4.00mA, it may be adjusted to 4.00mA by using the zero potentiometer and a small screwdriver.

 **Note:** Only a very fine adjustment should be required of zero potentiometer to adjust the 4-20mA integrated circuit. If a substantial adjustment is required, other problems probably exist and the factory should be consulted immediately.

7. Place the oxygen sensor in the bottom section of the sensor housing with the gold screen facing down towards the inside of the housing and the floor.
8. Place the top section of the sensor housing over the PCB and push the top section of the housing down onto the sensor located inside the bottom section of the housing.
9. Ensure the top and bottom section seat together.
10. Turn the top section of the sensor housing 90° and engage the clamp.
11. Using the 5/16 wrench provided tighten bolt and clamp the top and bottom sections of the sensor housing together.
12. Set the sample flow to 2 SCFH.
13. Allow the sensor and corresponding reading displayed by the LCD to stabilize before proceeding.

 **Note:** The time required for the sensor to stabilize is exponentially related to the time the sensor is exposed to air in an unshorted condition, see the caution note between steps 5 and 6 above.

14. Calibrate the transmitter with span gas or air as described above.

5 Operation

Calibration

Procedure #7 Span Gas Calibration – Transmitters NOT equipped with LCD display and sensor installed for shipment or in-service:

Applies to:

- Installed GPR-25 standard configuration – LCD and delrin sensor/flow housing
- In-service GPR-15 standard configuration – LCD and sensor with metal housing
- In-service GPR-25 optional configuration – LCD and sensor with metal housing

Notes:

 Span Gas - should have a value of oxygen concentration in N2 or Ar of 80-100% of full scale; example, for a 0-1% range, the span gas should be a certified grade of 0.9%.

1. Remove the front cover(s) of the transmitter and the screw(s) securing each.
 **Caution:** Do not remove or discard the gaskets from the enclosure or junction box. Failure to reinstall the gasket will void the NEMA rating.
2. Remove the wire inside the junction box connected to the terminal marked "negative".
3. Connect a milliampmeter in series between this wire and the terminal marked "negative".
4. Advance the range switch to the appropriate range.
5. Disconnect the sample gas line.
6. Assure there are no restrictions in the span gas line to be connected.
7. Set the span gas pressure between 5 and 30 psig; refer to the Pressure and Flow guidelines presented on page 5-2 of this section 5 Operation.
8. Connect the span gas line and tighten the compression tube fitting.
9. Set the flow of the span gas to 2 SCFH.
10. Allow the sensor and corresponding reading displayed by the milliampmeter to stabilize for at least 15 minutes.
11. With 0.90% span gas on the 0-1% range, the example from Procedure #1, adjust span potentiometer to 90% of full scale output or 18.4mA on the milliampmeter.
12. For any other span gas, the following formula must be used to calculate the output in mA.
$$(\text{Span Gas \% FS} \times 16 / 100) + 4 = \text{Output in mA}$$
13. Reverse steps 1 through 8 above and set flow to 2 SCFH.

5 Operation

Calibration

Procedure #8 Instrument Air Calibration – Transmitters NOT equipped with LCD display and sensor installed for shipment or in-service:

Except for step 11 and ignoring the Notes: Span Gas section, repeat Procedure #7 ensuring the range switch is set properly to the 0-25% CAL range.

The known concentration of air (20.9%) may be used as the standard for the 0-25% range.

With respect to step 11; with the known oxygen concentration of air (20.9%) as the standard, adjust the span potentiometer located on the PCB to 17.4mA on the milliammeter, as calculated by the formula in step 12.

Procedure #9 Ambient Air Calibration – Transmitters NOT equipped with LCD display and sensor installed for shipment or in-service:

Except for step 11, ignoring the Notes: Span Gas section and omitting steps 6 through 9, repeat Procedure #7 ensuring the range switch is set properly to the 0-25% CAL range.

The known concentration of air (20.9%) may be used as the standard for the 0-25% range.

With respect to step 11; with the known oxygen concentration of air (20.9%) as the standard, adjust the span potentiometer located on the PCB to 17.4mA on the milliammeter, as calculated by the formula in step 12.

Advanced Instruments Inc.

5 Operation

Alarms

The GPR-15A and GPR-25A Series Oxygen Transmitters are equipped with two high fully adjustable alarms. When activated the alarms trigger SPDT Form C non-latching relays @ 5A, 30VDC or 240VAC resistive.

The alarms are fully adjustable by the two potentiometer accessible from the auxiliary panel on the inside of the door.

Adjustment Procedure:

1. Remove the front cover to access the DISPLAY SELECT slide switch located on the PCB Assembly Main – refer to section 9 Specifications
2. Advanced the display selector switch to the ALARM 1 or ALARM 2. The display will indicate the current alarm setpoint.

Using a small bladed screw driver, adjust the potentiometer to display the desired alarm setpoint.

 The alarm setpoint represents the full scale of range. When the oxygen reading exceeds (high alarm) or falls below (low alarm) the alarm setpoint, the relay is activated and the corresponding LED indicator located on the front panel is also turned on.

 To prevent chattering of the relays, a 2% hysteresis is added to the alarm setpoint. This means that the alarm will remain active until the oxygen reading has fallen 2% below the alarm setpoint (high alarm) or risen 2% above the alarm setpoint (low alarm) after the alarm was activated.

Relays

The relays are Form C SPDT, normally closed, non-latching, rated at 5A, 30VDC, or 240VAC resistive.

Caution: *To avoid the possibility of electric shock exercise extreme caution when servicing the analyzer. Disconnect the power to the transmitter. If the power source remains connected to the terminal block, touching any terminal connections where power is present would result in an electric shock.*

Connections:

1. In order to access the terminals of the relays, use a small bladed screw driver to loosen the screws.
2. Loosen the terminal screws, insert the lug end of the cables into the appropriate terminal slots (see the interconnection wiring diagram Section 9 – Specifications) and retighten the screws to secure the cables.

Advanced Instruments Inc.

5 Operation

3. To connect to an active relay, connect the live cable to the common terminal COM and the secondary cable to the normally open NO terminal.
4. To break the connection upon relay activation, connect the secondary cable to the normally closed NC terminal.
5.  **Caution:** While connecting the cables to the relay terminals, ensure there is no voltage on the cables to prevent electric shock and possible damage to the analyzer. Further, ensure the lugs of the cables are fully inserted into the terminal slots and do not touch each other.
6. Once the connections are properly secured, replace the front cover

6 Maintenance

Zero maintenance

There are no moving parts in the transmitter given the modular nature of the electronics and sensor.

Cleaning the electrical contacts when replacing the sensor is the extent of the maintenance requirements of this transmitter.

Sensor Replacement

The sensor's operating characteristics are described in Section 5 - Operation, Principle of Operation. Section 8 - Troubleshooting details both common operating errors and the sensor's actual mode of failure.

Note:

 Accuracy – due to manufacturer tolerances there may be a slight difference between the LCD display and the analog output of the 4-20mA integrated circuit. However, the difference is less than 0.25% of range and falls well below the specified accuracy of the transmitter.

General Procedure – Delrin (Black) Sensor Housing:

1. Remove the front cover of the transmitter and the four (4) screws securing it.

 **Caution:** Do not remove or discard the gaskets from the enclosure. Failure to reinstall the gasket will void the NEMA rating.

2. Rotate the knurled lock nut connecting the cable to the sensor counter clockwise.
3. Remove the female plug (including the knurled lock nut) molded to the cable from the male receptacle attached to the sensor.
4. Rotate the sensor counter clockwise and remove the old sensor from the flow housing.
5. Open the barrier bag containing the new sensor.
6. If the sensor is equipped with a shorting loop, remove the shorting wire from the pins of the female socket attached to the new sensor.
7. Assuring the keyway registration of the plug and receptacle match up, push the female plug (including the knurled lock nut) molded to the cable into the male receptacle attached to the sensor.
8. Rotate the knurled lock nut connecting the cable to the sensor clockwise.
9. Advance the range switch to the 0-25% CAL range.
10. Expose the sensor to ambient air.
11. The known concentration of air (20.9%) may be used as the standard for the 0-25% range.

Advanced Instruments Inc.

6 Maintenance

12. Adjust the span potentiometer until the oxygen reading displayed by the LCD reaches 20.9%.
13. Rotate the sensor clockwise and install the new sensor into the flow housing. (Reverse of step 4 above.)
14. Reverse step 1 above to close the cover

General Procedure – Metal Sensor Housing:

1. Remove the front cover of the transmitter and the screw(s) securing it.

 **Caution:** Do not remove or discard the gasket from the enclosure. Failure to reinstall the gasket will void the NEMA rating.

1. Advance the range switch to the 0-25% CAL range.
2. Remove the top of the sensor housing by using the 5/16 wrench provided to loosen the clamp bolt, turning the top section of the sensor housing 90° and disengaging the clamp. Refer to drawing A-1004 (S/S) in Section 9 - Specifications.
3. Place the top section of the sensor housing on a smooth surface.
4. If installing a sensor for the first time go to step 9. If installing a replacement sensor, remove the old sensor from the sensor housing.
5. Once all preparations are complete, remove the new oxygen sensor from the barrier bag.
6. Remove the shorting device and gold ribbon from the PCB located at the rear of the sensor.

 **Caution:** Minimize the exposure to air. Do not remove the shorting device and let the sensor sit in air. In an unshorted condition, the sensor becomes saturated with unreacted oxygen resulting in longer clean up or recovery time and an inaccurate initial air calibration if the span adjustment is made before the sensor stabilizes.

8. Place the sensor on a flat surface with the PCB facing up.
9. Place the top of the sensor housing over the sensor's PCB and push the housing down onto the sensor. Ensure the PCB makes contact with the spring loaded contact pins inside the housing.
10. Allow the sensor and corresponding reading displayed by the LCD to stabilize for 10-15 minutes.
11. Adjust the span control until the display reads 20.9% oxygen.
12. Remove the top of the sensor housing and place the oxygen sensor in the bottom section of the sensor housing with the gold screen facing down towards the inside of the housing and the floor.
13. Place the top section of the sensor housing over the PCB and push the top section of the housing down onto the sensor located inside the bottom section of the housing.
14. Ensure the top and bottom section seat together.

6 Maintenance

15. Turn the top section of the sensor housing 90° and engage the clamp.
16. Using the 5/16 wrench provided tighten bolt and clamp the top and bottom sections of the sensor housing together.
17. Set the sample flow to 2 SCFH and begin sampling.

Advanced Instruments Inc.

7 Spare Parts

Recommended spare parts for the GPR-15 XP ppm O₂ Transmitter include:

<u>Item No.</u>	<u>Description</u>	<u>Price Each</u>
GPR-12-100-M	ppm Oxygen Sensor	\$ 200.00
XLT-12-100-M	ppm Oxygen Sensor (standard for CO2 background gas)	\$ 200.00
GPR-12-100-ML	ppm Oxygen Sensor (optional sub-freezing operation)	\$ 250.00
XLT-12-100-ML	ppm Oxygen Sensor (optional sub-freezing operation with CO2 background gas)	\$ 250.00

Other spare parts:

A-2708	Housing Flow Delrin Black with 1/8" SS Tube Fittings	\$ 200.00
MTR-1002	Meter Digital Panel LCD	\$ 100.00
MTR-1007	Meter Digital Panel LCD Sub-Freezing Operation -30°C	\$ 200.00
A-1139-M	PCB Assembly Main	\$ 800.00
TOOL-1001	Wrench Combination 5/16 (standard with optional A-1003 or A-1004)	\$ 10.00

Advanced Instruments Inc.

8 Troubleshooting

<i>Symptom</i>	<i>Possible Cause</i>	<i>Recommended Action</i>
Erratic or no oxygen reading in "on" position(s)	<ul style="list-style-type: none"> ▼ Change in ambient or sample pressure ▼ Dirty electrical contacts ▼ Liquid covering sensing membrane ▼ Presence of interference gases. ▼ Acid or sulfur gases shorten sensor life. ▼ Unauthorized maintenance resulting in reverse current being sent to sensor. ▼ Broken or defective electrical connection ▼ Sensor failure 	<ul style="list-style-type: none"> ▼ Calibrate the analyzer, see Section 5 - Operation. ▼ Clean contacts with alcohol and paper towel. ▼ Gently remove with alcohol and lint free towel. ▼ Consult factory. ▼ Replace sensor, see Section 6 - Maintenance. ▼ Replace sensor, see Section 6 - Maintenance. ▼ Obtain authorized service, see Section 10 - Warranty. ▼ Use voltmeter and determine uA output and contact factory with result.
Slow response time	<ul style="list-style-type: none"> ▼ Leaks, dead legs or low flowrate of sample line 	<ul style="list-style-type: none"> ▼ Leak test (below); reduce dead volume; increase flowrate, see Section 5 - Operation.
High oxygen reading	<ul style="list-style-type: none"> ▼ Leak in sample line or connections ▼ Inadequate control of pressure and flowrate ▼ Abnormality in sample or span gas 	<ul style="list-style-type: none"> ▼ Leak test: 1) vary flowrate, 2) the sensor is not flow sensitive, see Section 5 -Operation, Getting Started, Control of Pressure and Flow, 3) an oxygen reading changing inversely to the flowrate change indicates a leak, 4) qualify and correct source of leak. ▼ Correct, see Section 5 - Operation, Getting Started. ▼ Qualify source, check process records.
Oxygen reading drifts toward zero or significant number of turns of the span control adjustment is required to calibrate the analyzer.	<ul style="list-style-type: none"> ▼ Indication sensor is nearing end of life ▼ Analyzer was spanned / calibrated immediately after installing an unshorted sensor which no longer functions as a transducer and rapidly becomes saturated with oxygen when exposed to air. 	<ul style="list-style-type: none"> ▼ Replace sensor, see Section 6 - Maintenance. ▼ Allow the (sensor) oxygen reading to stabilize before spanning / calibrating the analyzer, purge with trace level oxygen gas to expedite. The time required to stabilize an unshorted sensor exponentially exceeds the time the sensor was unshorted and exposed to air.
High oxygen reading after replacing sensor	<ul style="list-style-type: none"> ▼ Exposure of sensor to air, failure to follow installation instructions accompanying sensor. ▼ Installation of an unshorted sensor, see above. ▼ Leak in sample line or connections. 	<ul style="list-style-type: none"> ▼ Sensor purges down to < 10 ppm in < 1 hour, purge with trace level oxygen gas to expedite. ▼ Allow the unshorted sensor to stabilize, see above. If problems persist replace sensor. ▼ Leak test, see above.

ppm Oxygen Transmitters

Two Wire 9-36V DC Loop Power

4-20mA Signal Output

Advanced Galvanic Sensors

0-100 ppm low range

Optional sub-freezing operating ranges

Explosion Proof Enclosure & Gas Ports

Suitable for Class 1, Division 1, Groups B, C, D use

Custom Sample Systems Optional

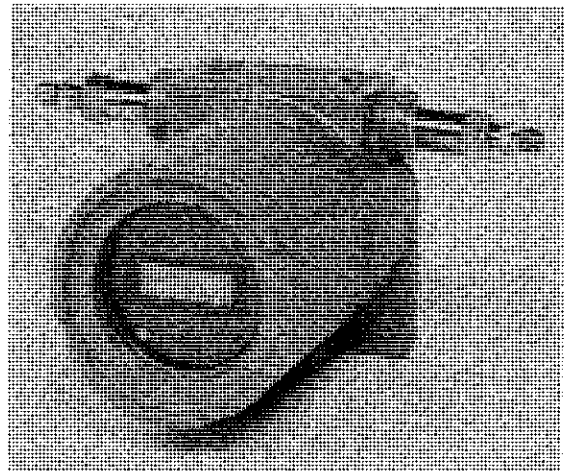

ISO 9001 Certified



GPR-15 XP

Technical Specifications

Ranges: 0-100 ppm, 0-25%

Accuracy:

At constant temperature: $\pm 2\%$ of full scale range

Over operating range: $\pm 5\%$ of full scale range

Sensitivity: $\pm 0.5\%$ of full scale range

Resolution of display: 0.1 ppm on 0-100 ppm range

Operating range:

0°C to +45°C (GPR or XLT-12-100-M sensors)

-30°C to +45°C (GPR-12-100-ML sensor, low temp LCD)

-25°C to +45°C (XLT-12-100-ML sensor, low temp LDC)

Response time 90% of full scale: 10 seconds

Drift: Less than 0.11% of reading per °C

Pressure: Sample inlet 5-30 psig, vent to atmosphere

Flow sensitivity: Insensitive between 1-5 SCFH

Calibration: 3-4 months using ambient air or certified gas approximating 80% of range or next higher

Application: Inert gases, gaseous hydrocarbons, He, H₂, mixed gases and acid (CO₂) gases;

specify XLT series sensors for use in acid gases

Sensors and expected sensor life at 25°C, 760mm Hg:

GPR or XLT-12-100-M sensors 18-24 months

GPR or XLT-12-100-ML sensors 18-24 months

Warranty: 1 year analyzer and sensor

Configuration

CE and ISO 9001 certified

Area class: Explosion proof wall mount enclosure and flame arrestors suitable for use in Class 1, Division 1, Groups B, C, D hazardous areas

Dimensions: 12x8x10", 15 lbs.

Sample System

Wetted parts: Stainless steel, delrin sensor

Connections: 1/8" compression tube fittings with approved flame arrestors standard

Line pressure: Inlet 5-30 psig, vent to atmosphere

Flow control: None, supplied by user or optional; recommended flow rate 2 SCFH

Electrical Features

Controls: Integral 4-20mA zero and span pots, and range selector switch

Display: 3-1/2 digit LCD

Signal output: 4-20mA negative ground

Power: 9-36V DC two wire loop power

Optional Equipment

Sub-freezing operating range (as above)

Range combinations as specified by user

Signal output: 1-5V non-loop power

Sample conditioning and H₂S scrubber systems

- COMPONENT LIST:**
- 1 GROUND SCREW
 - 2 TERMINAL SCREW
 - 3 CABLE GRIP
 - 4 LCD DIGITAL PANEL METER
 - 5 PPM SENSOR HOUSING
 - 6 BULKHEAD UNION 1/8" TUBE CONNECTION

RANGE 1: STANDARD 0-25% OXYGEN; OPTIONAL USER SPECIFIED
 RANGE 2: USER SPECIFIED MEASURING RANGE

NOTE: THE ELECTRONIC ZERO OFFSET AND OFFSET FOR THE
 4-20mA EI IC HAS BEEN SET AT THE FACTORY.

TO CHECK OR ADJUST THE ELECTRONIC ZERO OFFSET:

- 1 CONNECT OR INSTALL THE SENSOR
- 2 FLOW ZERO GAS ACROSS THE SENSOR
- 3 WAIT A MINIMUM OF 30 MINUTES FOR THE LCD READING (AND SENSOR) TO STABILIZE
- 4 SLIDE THE RANGE SWITCH TO RANGE 1
- 5 USE P2 TO OFFSET ANY ELECTRONIC SIGNAL ON THE LCD DISPLAY AND ADJUST UNTIL THE DISPLAY READS 00.0

TO CHECK OR ADJUST THE 4-20mA EI IC:

- 1 CONNECT AN AMMETER AS THE MEASURING DEVICE
- 2 ADJUST P3 UNTIL THE AMMETER READS 4mA
- 3 ONLY THE 4mA ADJUSTMENT IS AVAILABLE

TO CALIBRATE OR SPAN THE TRANSMITTER IN AIR:

- 1 INSTALL THE SENSOR
- 2 EXPOSE THE SENSOR TO AIR - SEE OWNER'S MANUAL
- 3 ADJUST P1 UNTIL:
 - THE LCD DISPLAY READS 20.9 (0-25% FULL SCALE RANGE) OR
 - THE AMMETER READS 17.97mA OR
 - THE AMMETER READS 3.34 V WITH 250 Ohm LOAD
- 4 CONSULT THE OWNER'S MANUAL FOR SPAN GAS CALIBRATION

NOTE: CONSULT OWNER'S MANUAL FOR DETAIL PROCEDURES

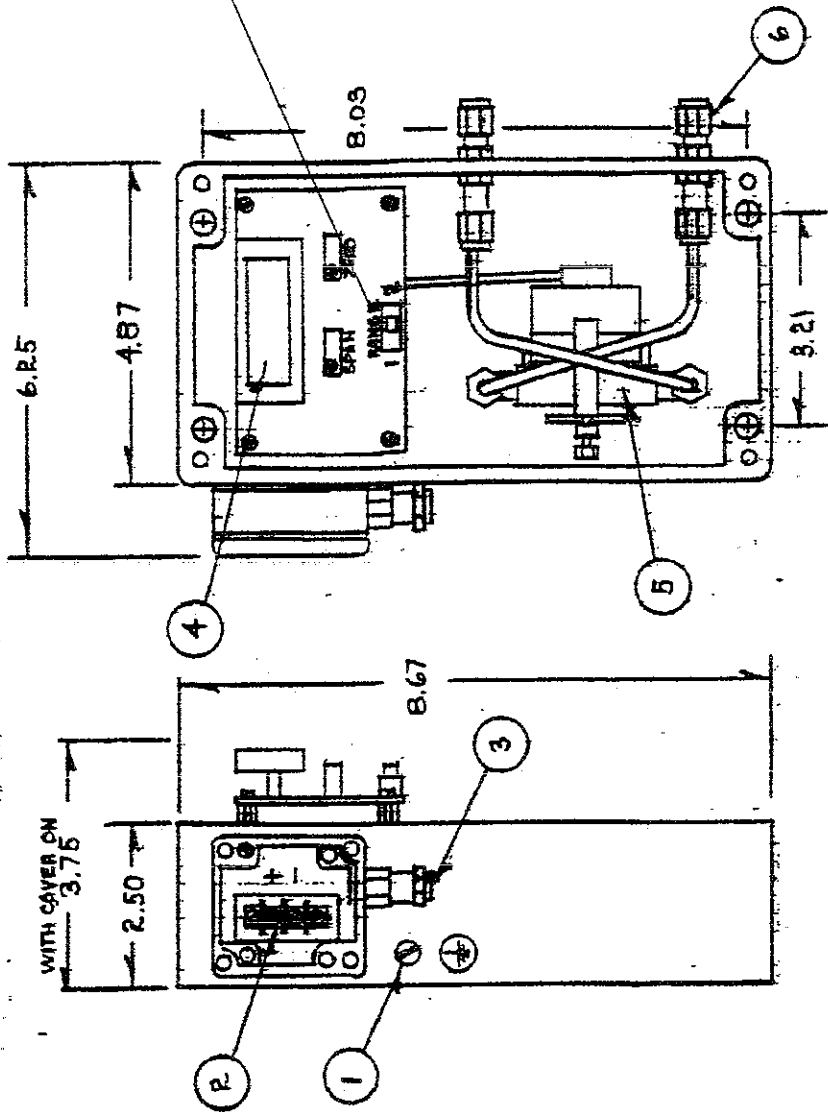

ELECTRICAL INTERCONNECTION:

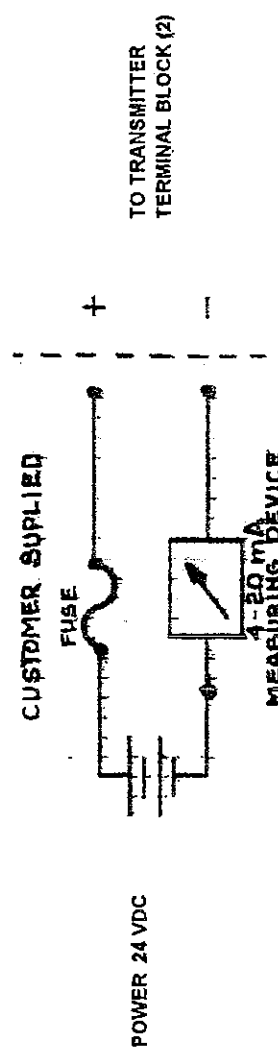

Advanced Instruments Inc.

THIS DRAWING IS THE PROPERTY OF ADVANCED INSTRUMENTS INC. AND CONTAINS CONFIDENTIAL INFORMATION. IT IS NOT TO BE COPIED, REPRODUCED, OR USED IN ANY MANNER WITHOUT WRITTEN PERMISSION.

TOLERANCE UNLESS OTHERWISE SPECIFIED	DATE	BY/CHK	DESCRIPTION
FRACTION ±.100"	SCALE	None	
DECIMAL ±.001"	DRAWN	ESG	PROCESS 1
ANGULAR ±1/2°	ENGINEER	ESG	PROCESS 2
DESCRIPTION:	APPROVAL	MR	DRAWING NO.:
GPR Series ppm O2 Transmitter Outline, interconnection			A-2407

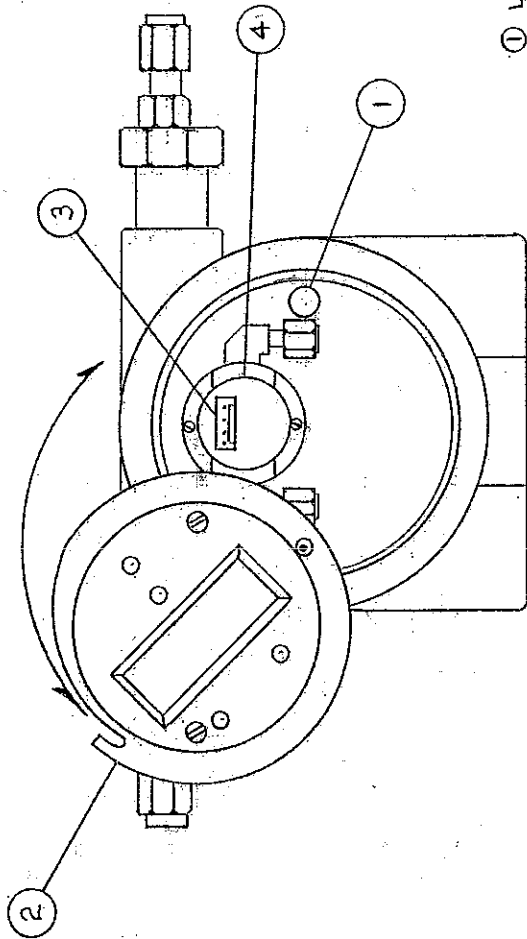

TO REPLACE SENSOR:

- ① LOOSEN THUMB SCREW.
- ② ROTATE PCB ASSEMBLY TO THE RIGHT AS SHOWN.
- ③ REMOVE MOLEX CONNECTOR FROM SENSOR.
- ④ UNSCREW SENSOR AND REPLACE.

ITEM	PART NO.	QTY	DESCRIPTION
Advanced Instruments Inc.			
<small>THIS DRAWING IS THE PROPERTY OF ADVANCED INSTRUMENTS INC. AND CONTAINS CONFIDENTIAL INFORMATION. IT IS NOT TO BE COPIED, REPRODUCED, SCANNED OR USED IN ANY MANNER WITHOUT WRITTEN PERMISSION.</small>			
TOLERANCE UNLESS OTHERWISE SPECIFIED	DATE	19-17-01	MATERIAL ITEM NO.
FRACTION $\pm .124$ "	SCALE	1/2	DESCRIPTION
DECIMAL $\pm .005$ "	DRAWN BY	FSG	PROCESS 1
ANGULAR $\pm 1/2$	ENGINEER	FSG	PROCESS 2
	APPROVAL	[Signature]	DRAWING NO.:
			B-2744
DESCRIPTION: 6FR-15 XP, 15A XP			SENSOR REPLACEMENT DIAGRAM

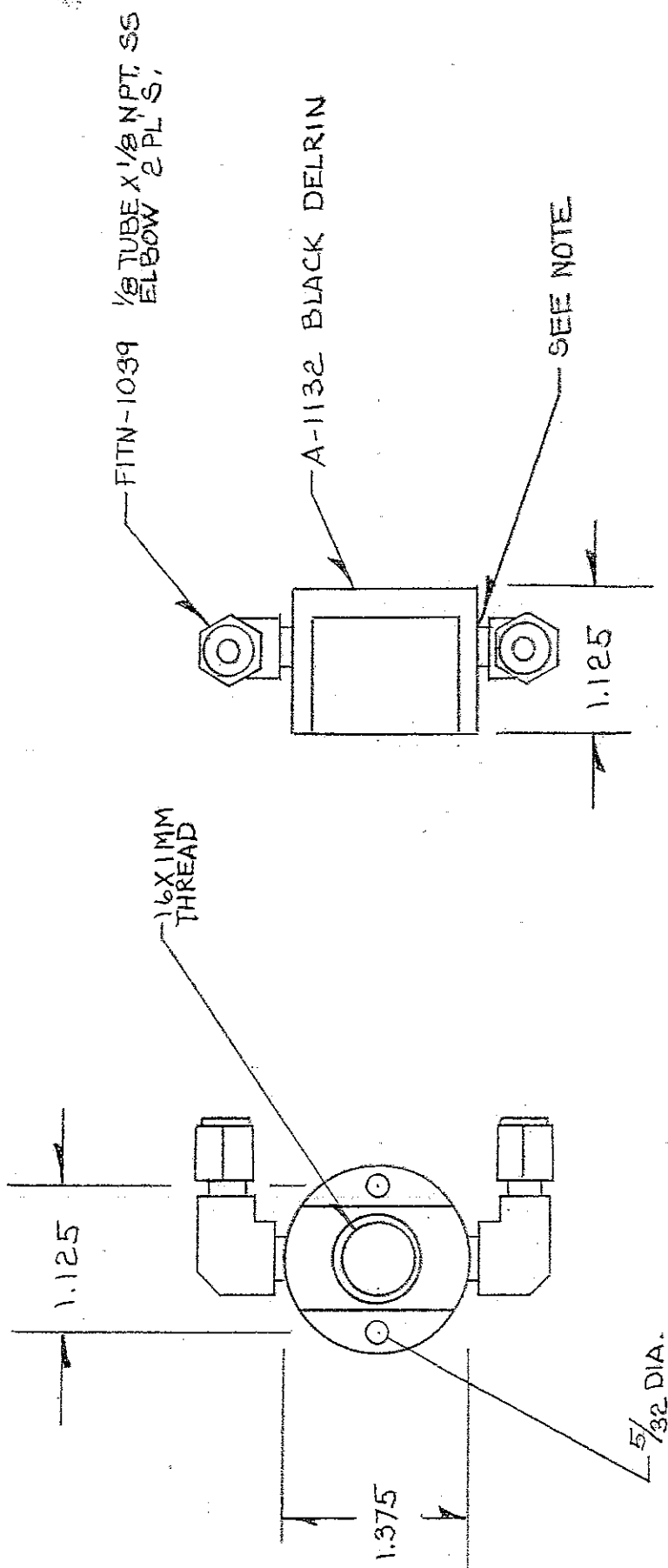

NOTE:

USE TEFLON TAPE 3 TIMES AROUND
 INSTALL FITTING, USE 5 MIN. EPOXY, APPLY AROUND
 THREAD. AFTER ASSEMBLY IN INST. AND TUBED
 USE A DROP OF SUPER GLUE AROUND THREAD

Advanced Instruments Inc.

THIS DRAWING IS THE PROPERTY OF ADVANCED INSTRUMENTS INC. AND CONTAINS CONFIDENTIAL INFORMATION.
 IT IS NOT TO BE COPIED, REPRODUCED, SCANNED OR USED IN ANY MANNER WITHOUT WRITTEN PERMISSION.

TOLERANCE UNLESS OTHERWISE SPECIFIED FRACTION $\pm 1/64$ DECIMAL $\pm .005$ ANGULAR $\pm 1/2$	DATE 8-6-01	MATERIAL ITEM NO. DESCRIPTION
SCALE DRAFTER ENGINEER APPROVAL	PROCESS 1 PROCESS 2	DRAWING NO.: A-2708
DESCRIPTION: GPR-15AD, 15XP, 15AXP, 25XP, 25AXP		
FLOW THROUGH ADAPTOR		

ELECTRONIC ZERO
OFFSET

4 - 2.0 mA OFFSET

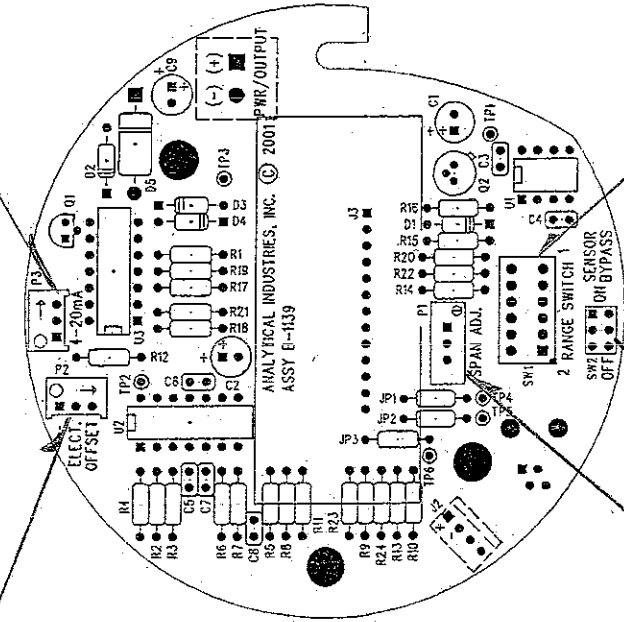

SPAN

RANGE SWITCH
RANGE 1 = 25%
RANGE 2 = USER SPECIFIED

SENSOR BYPASS SWITCH;
KEEP SWITCH OFF FOR NORMAL
OPERATION.

TO CHECK ELECTRONIC ZERO TURN
SWITCH TO ON (WITH SENSOR
INSTALLED) THE DISPLAY WILL
SHOW 00.0 +.1 IF OFFSET IS
MORE THEN .1. USE POTENTIOMETER
P2 TO ADJUST.

TOP ASSEMBLY DRAWING

Advanced Instruments Inc.

THIS DRAWING IS THE PROPERTY OF ADVANCED INSTRUMENTS INC. AND CONTAINS CONFIDENTIAL INFORMATION.
IT IS NOT TO BE COPIED, REPRODUCED, SCANNED OR USED IN ANY MANNER WITHOUT WRITTEN PERMISSION.

TOLERANCE UNLESS
OTHERWISE SPECIFIED
FRACTION $\pm .1/64$
DECIMAL $\pm .005$
ANGULAR $\pm 1/2$

DATE: 10-16-01
SCALE: N
DRAFTER: FSG
ENGINEER: FSG
APPROVAL: M

MATERIAL ITEM NO.
DESCRIPTION
PROCESS 1
PROCESS 2

DESCRIPTION: GPR-15, 25 X P
CONTROLS LOCATIONS
TRANSMITTER

DRAWING NO.:
B-1139

POWER IN, 4-20 mA OUT,
 12 - 36 VDC LOOP-POWERED.
 13 - 36 VDC PREFERRED.

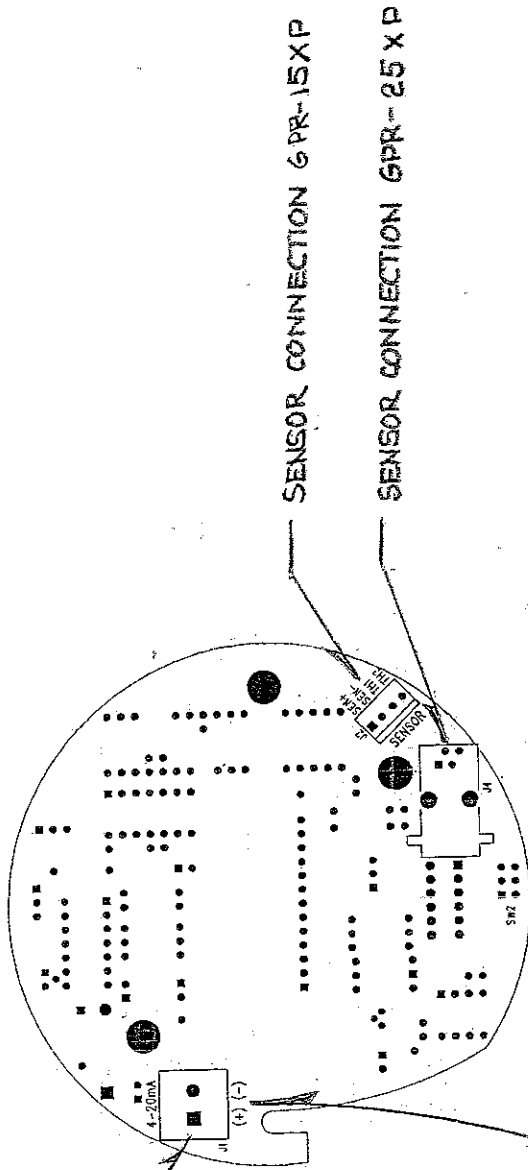

ELECTRICAL INTERCONNECTION

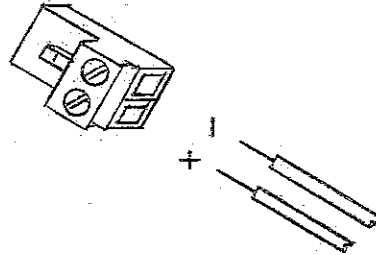
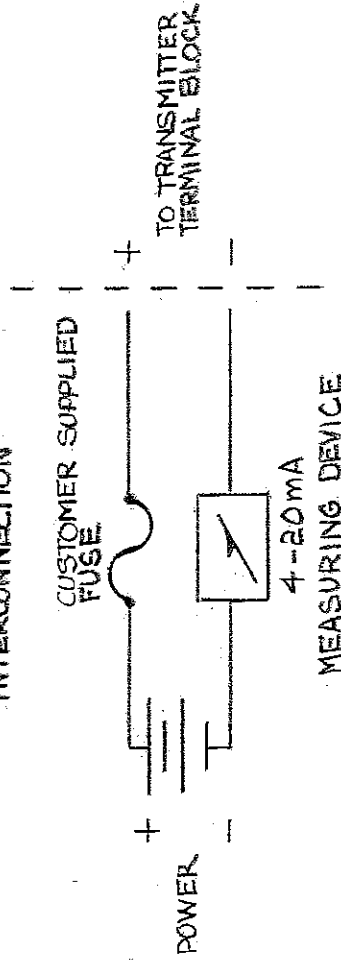

POWER, CUSTOMER SUPPLIED

BACK ASSEMBLY DWG.

Advanced Instruments Inc.

THIS DRAWING IS THE PROPERTY OF ADVANCED INSTRUMENTS INC. AND CONTAINS CONFIDENTIAL INFORMATION. IT IS NOT TO BE COPIED, REPRODUCED, SCANNED OR USED IN ANY MANNER WITHOUT WRITTEN PERMISSION.

TOLERANCE UNLESS OTHERWISE SPECIFIED	DATE	MATERIAL ITEM NO.
FRACTION $\pm 1/64$	10-16-01	DESCRIPTION
DECIMAL $\pm .005$	SCALE $1/4$	PROCESS 1
ANGULAR $\pm 1/2$	DRAFTER FSG	PROCESS 2
	ENGINEER FSG	DRAWING NO.:
	APPROVAL <i>[Signature]</i>	B-1139-1
DESCRIPTION: GPR-15-25 XP INTERCONNECTION TRANSMITTER		

Advanced Instruments Inc.

10 Warranty

How to obtain warranty service:

Do-It-Yourself-Service

Call Advanced Instruments Inc. at 909-392-6900 between 8:00am and 5:00pm Pacific Time weekdays. Trained technicians will assist you in diagnosing the problem and arrange to supply you with the required parts.

Service from Distributors

If warranty service is provided by a distributor, Advanced Instruments Inc. will provide all required parts under warranty at no charge to you, but the distributor is an independent business and may render a service charge for their services. Advanced Instruments Inc. will not reimburse you or otherwise be responsible for those charges.

Return to Advanced Instruments Inc.

You may obtain warranty service by returning you analyzer, postage prepaid to:

Advanced Instruments Inc.
2855 Metropolitan Place
Pomona, Ca 91767 USA

Be sure to pack the analyzer securely. Include your name, address, telephone number, proof of date of purchase and a description of the operating problem. After repairing or, at our option, replacing your Advanced Instruments Inc. analyzer, we will ship it to you at no cost for parts and labor.

Your choice of any one of the service options described above is your exclusive remedy under this warranty.

What is not covered:

This warranty does not cover installation; defects resulting from accidents; damage while in transit to our service location; damage resulting from alterations, misuse or abuse; lack of proper maintenance; unauthorized repair or modification of the analyzer; affixing of any attachment not provided with the analyzer; fire, flood, or acts of God; or other failure to follow the Owner's Manual.

Sole Warranty

This warranty is the only one we will give on your Advanced Instruments Inc. analyzer, and it sets forth all our responsibilities regarding your Advanced Instruments Inc. analyzer.

There are no other express warranties.

Advanced Instruments Inc.

10 Warranty

What is covered:

Any defect in material and workmanship from normal use in accordance with the Owner's Manual.

This warranty applies to all analyzers purchased worldwide. Advanced Instruments Inc. reserves the right in its sole discretion to invalidate this warranty if the serial number does not appear on the analyzer.

For how long:

One year from shipment by manufacturer or purchase from a distributor with proof of purchase.

Who is warranted:

This warranty is limited to the first customer who submits a claim. Under no circumstances will the warranty extend to more than one customer.

What we will do:

If your Advanced Instruments Inc. analyzer is defective with respect to material and workmanship, we will repair it or, at our option, replace it at no charge to you.

If we choose to replace your Advanced Instruments Inc. analyzer, we may use new or reconditioned replacement parts.

If we choose to replace your Advanced Instruments Inc. analyzer, we may replace it with a new or reconditioned one of the same or upgraded design.

Limitations:

Implied warranties, including those of fitness for a particular purpose and merchantability (an unwritten warranty that the product is fit for ordinary use), are limited to one year from the date of shipment by manufacturer or purchase from a distributor with proof of purchase.

Advanced Instruments Inc. will not pay for: loss of time; inconvenience; loss of use of your Advanced Instruments Inc. analyzer or property damage caused by your Advanced Instruments Inc. analyzer or its failure to work; any special, incidental or consequential damages; or any damage resulting from alterations, misuse or abuse; lack of proper maintenance; unauthorized repair or modification of the analyzer; affixing of any attachment not provided with the analyzer or other failure to follow the Owner's Manual.

Some states and provinces do not allow limitations on how an implied warranty lasts or the exclusion of incidental or consequential damages, so the above exclusions may not apply to you. This warranty gives you specific legal rights, and you may also have other rights which vary from state to state and province to province.

Analytical Industries Inc.

Material Safety Data Sheet

Product Identification

Product Name Oxygen Sensor Models CAD, GPR, PSR, SAF, 67013
Synonyms Galvanic Fuel Cell, Electrochemical Transducer
Manufacturer Analytical Industries Inc.
2855 Metropolitan Place, Pomona, CA 91767 USA
Emergency Phone Number 909-392-6900
Preparation / Revision Date January 1, 1995
Notes
▼ Oxygen sensors are sealed, contain protective coverings and in normal conditions do not present a health hazard.
▼ Information applies to electrolyte unless otherwise noted.

Specific Generic Ingredients

Carcinogens at levels > 0.1% None
Others at levels > 1.0% Potassium Hydroxide, Lead
CAS Number Potassium Hydroxide = KOH 1310-58-3, Lead = Pb 7439-92-1
Chemical (Synonym) and Family Potassium Hydroxide (KOH) - Base, Lead (Pb) - Metal

General Requirements

Use Potassium Hydroxide - electrolyte, Lead - anode
Handling
▼ Rubber or latex gloves
▼ Safety glasses
Storage Indefinitely

Physical Properties

Boiling Point Range 100 to 115° C
Melting Point Range KOH -10 to 0° C, Lead 327° C
Freezing Point -40 to 0° C
Molecular Weight KOH = 56, Lead = 207
Specific Gravity 1.09 @ 20° C
Vapor Pressure Not applicable
Vapor Density Not applicable
pH > 14
Solubility in H₂O Complete
% Volatiles by Volume None
Evaporation Rate Similar to water
Appearance and Odor Colorless, odorless aqueous solution

Analytical Industries Inc.

Fire and Explosion Data

Flash and Fire Points	Not applicable
Flammable Limits	Not flammable
Extinguishing Method	Not applicable
Special Fire Fighting Procedures	Not applicable
Unusual Fire and Explosion Hazards	Not applicable

Reactivity Data

Stability	Stable
Conditions Contributing to Instability	None
Incompatibility	Avoid contact with strong acids
Hazardous Decomposition Products	None
Conditions to Avoid	None

Spill or Leak

Steps if material is released	<ul style="list-style-type: none">▼ Sensor is packaged in a sealed protective plastic bag, check the sensor inside for electrolyte leakage.▼ If the sensor leaks inside the protective plastic bag or inside an analyzer sensor housing do not remove it without rubber or latex gloves and safety glasses and a source of water.▼ Flush or wipe all surfaces repeatedly with water or wet paper towel. Use a fresh towel each time.
-------------------------------	--

Waste Disposal Method In accordance with federal, state and local regulations

Health Hazard Information

Primary Route(s) of Entry	Ingestion, eye and skin contact
Exposure Limits	Potassium Hydroxide - ACGIH TLV 2 mg/cubic meter Lead - OSHA PEL .05 mg/cubic meter

Effects of Exposure -

Ingestion	Electrolyte could be harmful or fatal if swallowed. Oral LD50 (RAT) = 2433 mg/kg
Eye	Electrolyte is corrosive and eye contact could result in permanent loss of vision.
Skin	Electrolyte is corrosive and skin contact could result in a chemical burn.
Inhalation	Liquid inhalation is unlikely.
Symptoms	<ul style="list-style-type: none">▼ Eye contact - burning sensation.▼ Skin contact - soapy slick feeling.

Medical Conditions Aggravated

Carcinogenic Reference Data	None
	<ul style="list-style-type: none">▼ NTP Annual Report on Carcinogens - not listed▼ LARC Monographs - not listed▼ OSHA - not listed

Other Lead is listed as a chemical known to the State of California to cause birth defects or other reproductive harm.

Analytical Industries Inc.

Emergency First Aid

Ingestion

- ▼ Do not induce vomiting.
- ▼ Give plenty of cold water.
- ▼ Seek medical attention immediately.

Skin Contact

- ▼ Wash affected area repeatedly with plenty of water.
- ▼ Remove contaminated clothing.
- ▼ If burning persists, seek medical attention.

Eye Contact

- ▼ Flush repeatedly with plenty of water for at least 15 minutes.
- ▼ Seek medical attention immediately.

Inhalation

- ▼ Liquid inhalation is unlikely.

Special Protection Information

Ventilation Requirements

None

Eye

Safety glasses

Hand

Rubber or latex gloves

Respirator Type

Not applicable

Other Protective Equipment

None

Special Precautions

Precautions

- ▼ Do not remove the sensor's protective Teflon and PCB coverings.
- ▼ Do not probe the sensor with sharp objects.
- ▼ Wash hands thoroughly after handling.
- ▼ Avoid contact with eyes, skin and clothing.
- ▼ Empty sensor body may contain hazardous residue.

Transportation

Not applicable

Analytical Industries Inc.

Material Safety Data Sheet

Product Identification

Product Name	Oxygen Sensor Models XLT
Synonyms	Galvanic Fuel Cell, Electrochemical Transducer
Manufacturer	Analytical Industries Inc. 2855 Metropolitan Place, Pomona, CA 91767 USA
Emergency Phone Number	909-392-6900
Preparation / Revision Date	January 1, 1995
Notes	▼ Oxygen sensors are sealed, contain protective coverings and in normal conditions do not present a health hazard. ▼ Information applies to electrolyte unless otherwise noted.

Specific Generic Ingredients

Carcinogens at levels > 0.1%	None
Others at levels > 1.0%	Acetic Acid, Lead
CAS Number	Acetic Acid = 64-19-7, Lead = Pb 7439-92-1
Chemical (Synonym) and Family	Acetic Acid (CH ₃ CO ₂ H) - Acid, Lead (Pb) - Metal

General Requirements

Use	Acetic Acid - electrolyte, Lead - anode
Handling	▼ Rubber or latex gloves ▼ Safety glasses
Storage	Indefinitely

Physical Properties

Boiling Point Range	100 to 117° C
Melting Point Range	Acetic Acid = not applicable, Lead 327° C
Freezing Point	-40 to -10° C
Molecular Weight	Acetic Acid = not applicable, Lead = 207
Specific Gravity	1.05 @ 20° C
Vapor Pressure	11.4 @ 20° C
Vapor Density (air = 1)	2.07
pH	2-3
Solubility in H ₂ O	Complete
% Volatiles by Volume	None
Evaporation Rate	Similar to water
Appearance and Odor	Colorless, vinegar-like odor aqueous solution

Analytical Industries Inc.

Fire and Explosion Data

Flash and Fire Points
Flammable Limits
Extinguishing Method
Special Fire Fighting Procedures
Unusual Fire and Explosion Hazards

Not applicable
Not flammable
Not applicable
Not applicable
Not applicable

Reactivity Data

Stability
Conditions Contributing to Instability
Incompatibility
Hazardous Decomposition Products
Conditions to Avoid

Stable
None
Avoid contact with strong bases
Emits toxic fumes when heated
Heat

Spill or Leak

Steps if material is released

- ▼ Sensor is packaged in a sealed protective plastic bag, check the sensor inside for electrolyte leakage.
- ▼ If the sensor leaks inside the protective plastic bag or inside an analyzer sensor housing do not remove it without rubber or latex gloves, safety glasses and a source of water.
- ▼ Flush or wipe all surfaces repeatedly with water or wet paper towel. Use a fresh towel each time.

Waste Disposal Method

in accordance with federal, state and local regulations

Health Hazard Information

Primary Route(s) of Entry
Exposure Limits

Ingestion, eye and skin contact
Acetic Acid - ACGIH TLV / OSHA PEL 10 ppm (TWA),
Lead - OSHA PEL .05 mg/cubic meter

Effects of Exposure -
Ingestion

Electrolyte could be harmful or fatal if swallowed.
Oral LD50 (RAT) = 6620 mg/kg

Eye

Electrolyte is corrosive and eye contact could result in permanent loss of vision.

Skin

Electrolyte is corrosive and skin contact could result in a chemical burn.

Inhalation

Liquid inhalation is unlikely.

Symptoms

- ▼ Eye contact - burning sensation.
- ▼ Skin contact - burning sensation.

Medical Conditions Aggravated
Carcinogenic Reference Data

None
▼ NTP Annual Report on Carcinogens - not listed
▼ LARC Monographs - not listed
▼ OSHA - not listed

Other

Lead is listed as a chemical known to the State of California to cause birth defects or other reproductive harm. Lead acetate formed as the sensor is used is listed as a chemical known to the State of California to cause cancer.

Analytical Industries Inc.

Emergency First Aid

Ingestion

- ▼ Do not induce vomiting.
- ▼ Give plenty of cold water or if available milk.
- ▼ Seek medical attention immediately.

Skin Contact

- ▼ Wash affected area repeatedly with plenty of water.
- ▼ Remove contaminated clothing.
- ▼ If burning persists, seek medical attention.

Eye Contact

- ▼ Flush repeatedly with plenty of water for at least 15 minutes.
- ▼ Seek medical attention immediately.

Inhalation

- ▼ Liquid inhalation is unlikely.

Special Protection Information

Ventilation Requirements

None

Eye

Safety glasses

Hand

Rubber or latex gloves

Respirator Type

Not applicable

Other Protective Equipment

None

Special Precautions

Precautions

- ▼ Do not remove the sensor's protective Teflon and PCB coverings.
- ▼ Do not probe the sensor with sharp objects.
- ▼ Wash hands thoroughly after handling.
- ▼ Avoid contact with eyes, skin and clothing.
- ▼ Empty sensor body may contain hazardous residue.

Transportation

Not applicable